

	(1)		(2)			(3)			(4)
							120Vac	220Vac	



			±	
			±	
			°	°

°



				∞ ∞
				∞

o

EMI	
EMS	

EMS	
DALI	

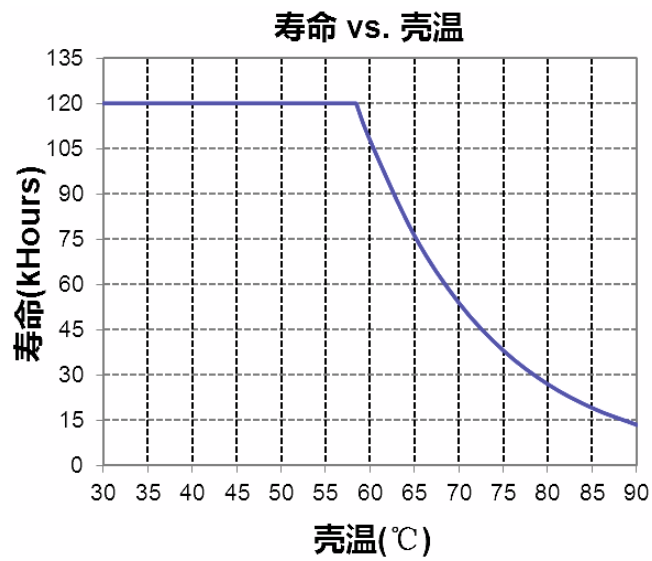

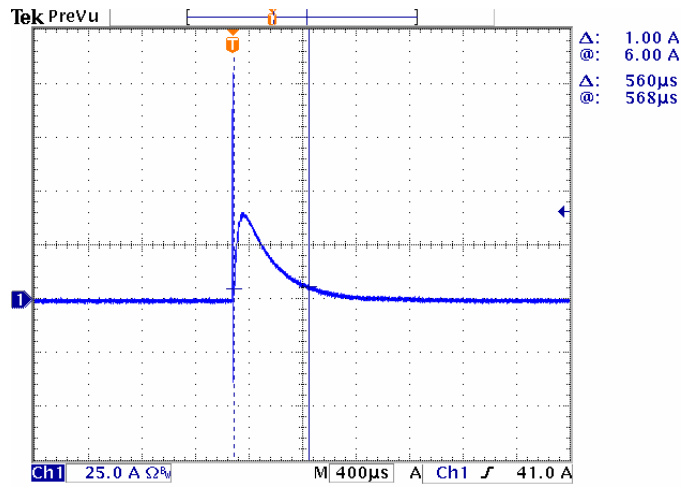

LUD-060S055BS2 (Io=385mA)  
效率 vs. 输出电压

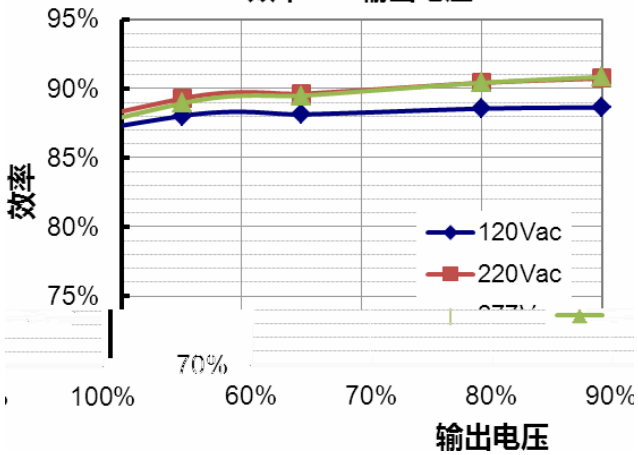

LUD-060S055BS2 (Io=550mA)  
效率 vs. 输出电压

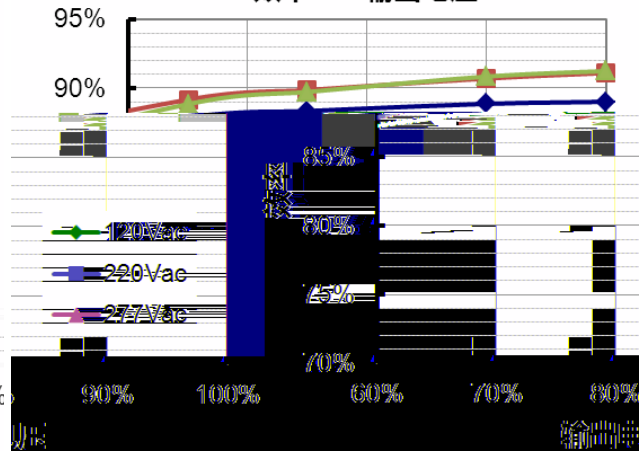

LUD-060S078BS2 (Io=546mA)  
效率 vs. 输出电压

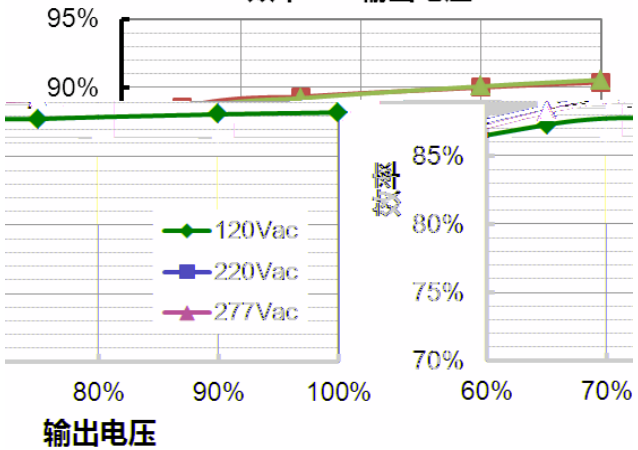

LUD-060S078BS2 (Io=780mA)  
效率 vs. 输出电压

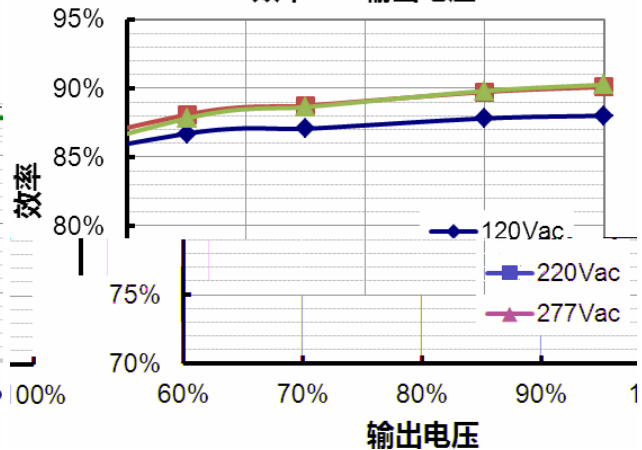

LUD-060S110BS2 (Io=770mA)  
效率 vs. 输出电压

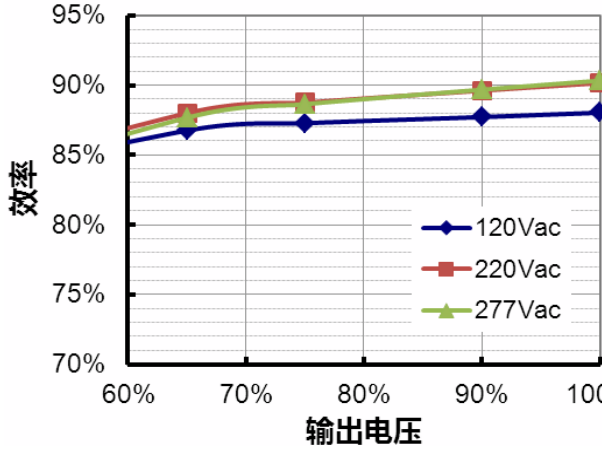

LUD-060S110BS2 (Io=1100mA)  
效率 vs. 输出电压

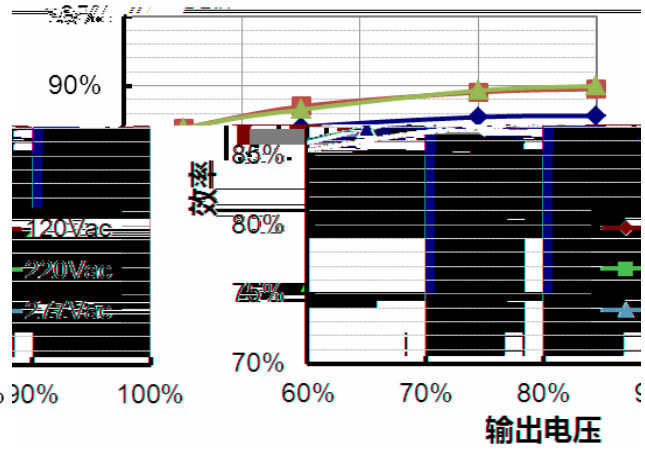

LUD-060S150BS2 (Io=1050mA)  
效率 vs. 输出电压

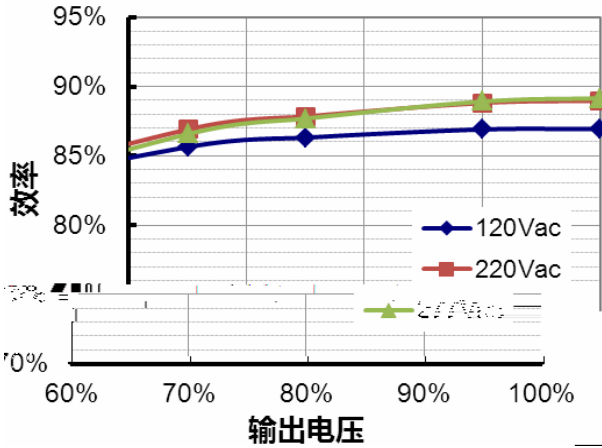

LUD-060S150BS2 (Io=1500mA)  
效率 vs. 输出电压

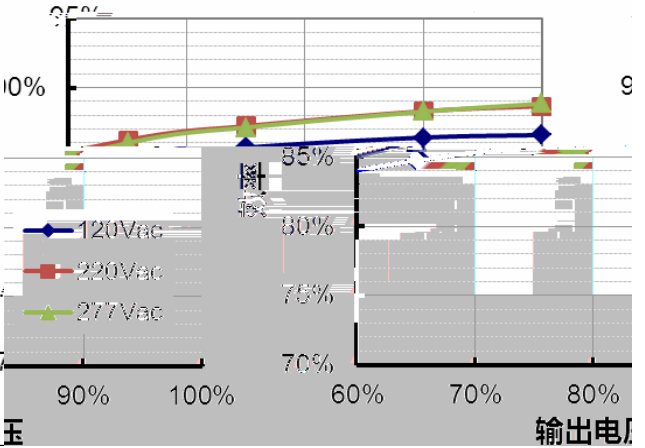

LUD-060S210BS2 (Io=1470mA)  
效率 vs. 输出电压

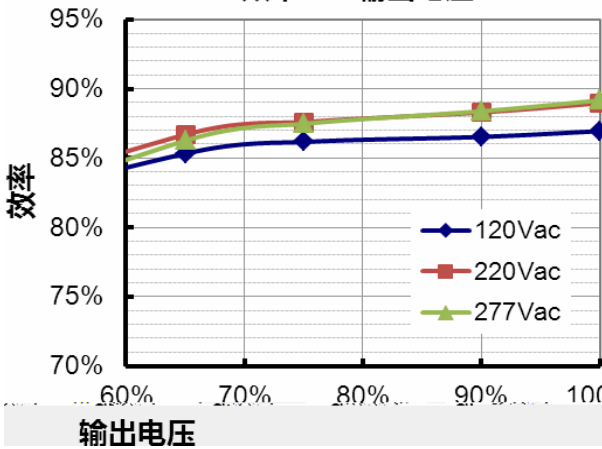

LUD-060S210BS2 (Io=2100mA)  
效率 vs. 输出电压

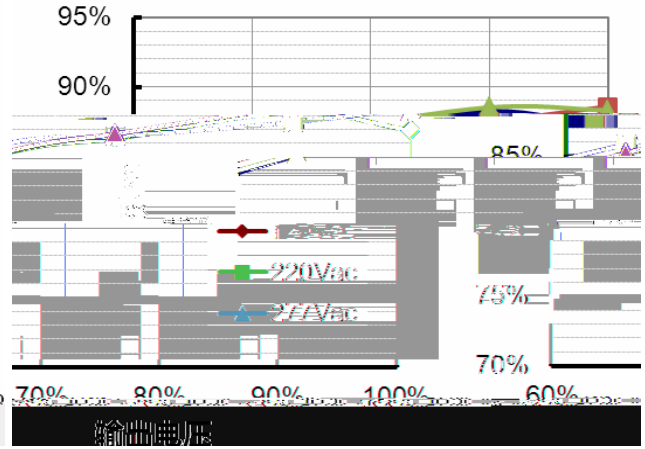



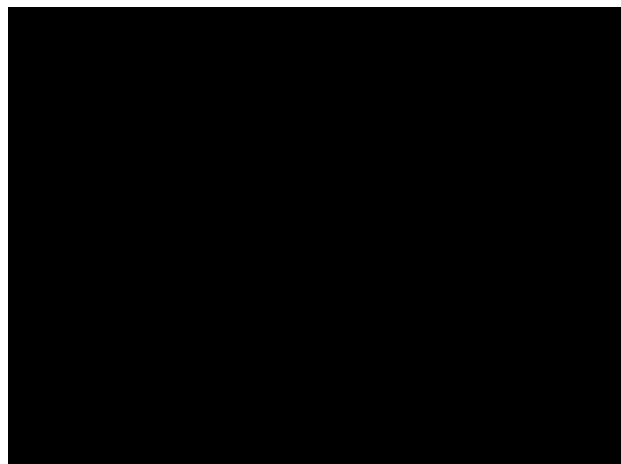
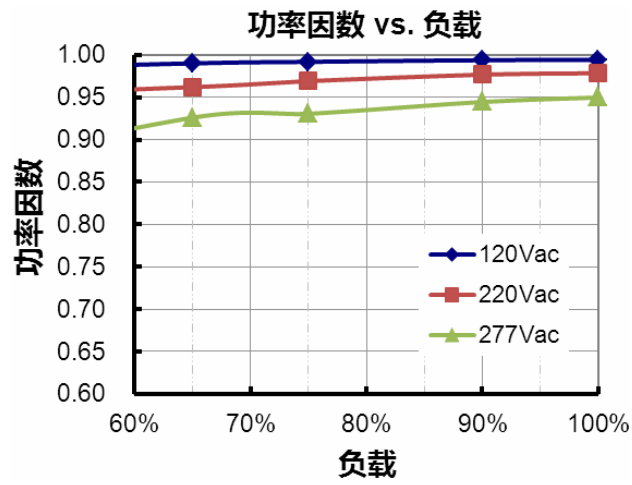

				M

● DALI

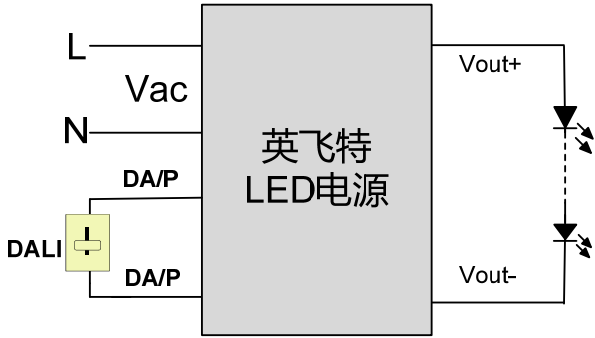

对数调光曲线

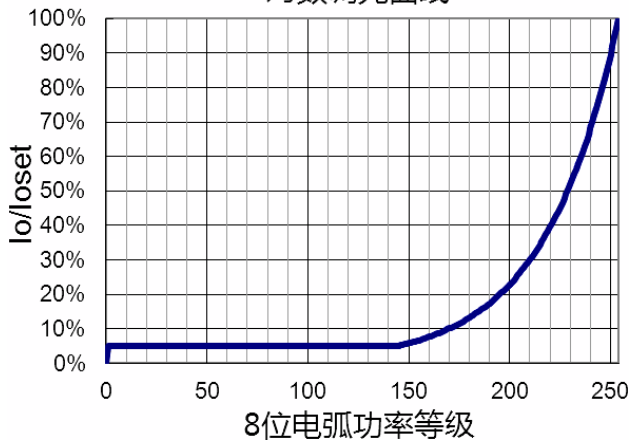

线性调光曲线

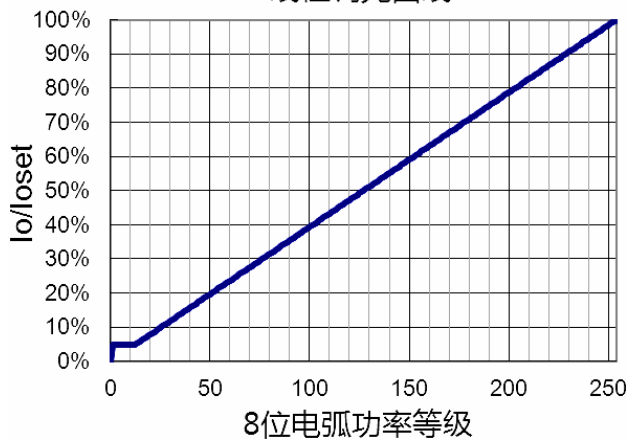

DALI

●

				≤ ≤
				≤

- 

- DALI



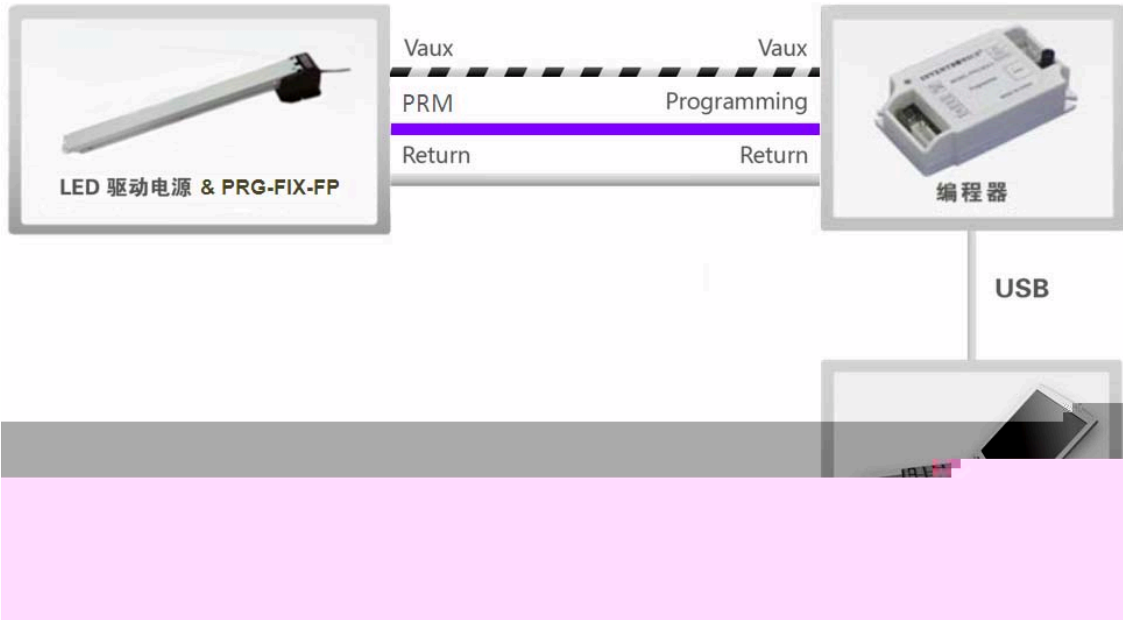

[PRG-FIX-FP](#)

[PRG-MUL2](#)

